

3G-AMA Mini-Converter

4-Ch Balanced Embedder/Disembedder



Installation and Operation Guide

Version 1.2
Published October 23, 2023



Notices

Trademarks

AJA® and Because it matters.® are registered trademarks of AJA Video Systems, Inc. for use with most AJA products. AJA™ is a trademark of AJA Video Systems, Inc. for use with recorder, router, software and camera products. Because it matters.™ is a trademark of AJA Video Systems, Inc. for use with camera products.

CION®, Corvid Ultra®, lo®, Ki Pro®, KONA®, KUMO®, ROI® and T-Tap® are registered trademarks of AJA Video Systems, Inc.

AJA Control Room™, KiStor™, Science of the Beautiful™, TruScale™, TruZoom™, V2Analog™ and V2Digital™ are trademarks of AJA Video Systems, Inc.

All other trademarks are the property of their respective owners.

Copyright

Copyright © 2023 AJA Video Systems, Inc. All rights reserved. All information in this manual is subject to change without notice. No part of the document may be reproduced or transmitted in any form, or by any means, electronic or mechanical, including photocopying or recording, without the express written permission of AJA Video Systems, Inc.

Contacting AJA Technical Support or Sales

Please have all pertinent information at hand prior to contacting AJA support or sales.

Support Telephone: +1.530.271.3190

Support Website: <https://www.aja.com/support/contact>

Support Email: support@aja.com

Sales Email: sales@aja.com

Shipping Address: AJA Video Systems
180 Litton Drive
Grass Valley, CA 95945, USA

Contents

Notices	2
Trademarks	2
Copyright	2
Contacting AJA Technical Support or Sales	2
Chapter 1 – Introduction	4
Overview	4
Features	4
3G-AMA Simplified Block Diagram	5
3G-AMA I/O Connections	5
Lock LED Status Indicators	5
User Controls	6
DIP Switches	6
Mini-Config Control	6
Installation	6
Breakout Cable Pinouts	7
Chapter 2 – Operation	8
Default Operational Settings	8
DIP Switches	8
DIP Switch Settings	8
Switches 4 and 5 Channel Mapping For Embedded Groups	9
Switches 6 and 7 Channel Mapping For Disembedded Groups	10
USB Control and Setup—Using AJA Mini-Config	10
Acquiring Mini-Config	10
Installing Mini-Config	11
Running Mini-Config	12
Operating Mini-Config	14
Tabbed Screens	15
Audio-1 Tab Screen	15
Analog Audio Inputs	15
Analog Audio Outputs	16
Audio-2 Tab Screen	16
Packet Processing Control	16
Analog Audio Levels	17
About Audio Levels	17
Update Tab Screen	17
Info Tab Screen	18
Appendix A – Specifications	20
3G-AMA Tech Specs	20
Appendix B – Safety and Compliance	22
Warranty and Liability Information	30
Index	31

Chapter 1 – Introduction



Overview

The 3G-AMA is a triple rate 4 channel analog audio embedder/disembedder. Analog audio can be embedded and disembedded simultaneously. The embedder is user selectable, on a channel pair basis, to either pass input audio or embed input audio from the provided breakout cable. The ability to pass incoming ancillary data makes it possible to embed up to 16 channels of audio by cascading four units. Horizontal ancillary data (HANC) packets in compliance with SMPTE 291M can also be dropped at the input. Analog audio levels are selectable, via USB connection and Mini-Config software.

The 3G-AMA automatically detects and configures to the input video standard. 3G-SDI formats up to and including 2048x1080p 60 YCbCr 4:2:2 are supported (see "[Appendix A Specifications](#)" on page 20 for a complete listing). SDI video loops through the device with minimal delay. Loop through embedded SDI audio supports up to 16 channels.

NOTE: 2048x1080p/psf 29.97 and 30 formats support a maximum of 8 channels embedded audio.

Features

- Triple rate 3G, HD, and SD-SDI Embedder/Disembedder
- 4 Channel Balanced Analog Audio I/O
- Supplied breakout cable for balanced analog audio - XLR connectors.
- 1 x BNC 3G-SDI input
- 1 x BNC 3G-SDI output
- Setup via DIP switch or PC/Mac using USB port and supplied USB cable (Mini-Config configuration software application available via download from AJA website)
- Uses universal input +5V power supply AJA model DWP-U-R1 (included)

3G-AMA Simplified Block Diagram

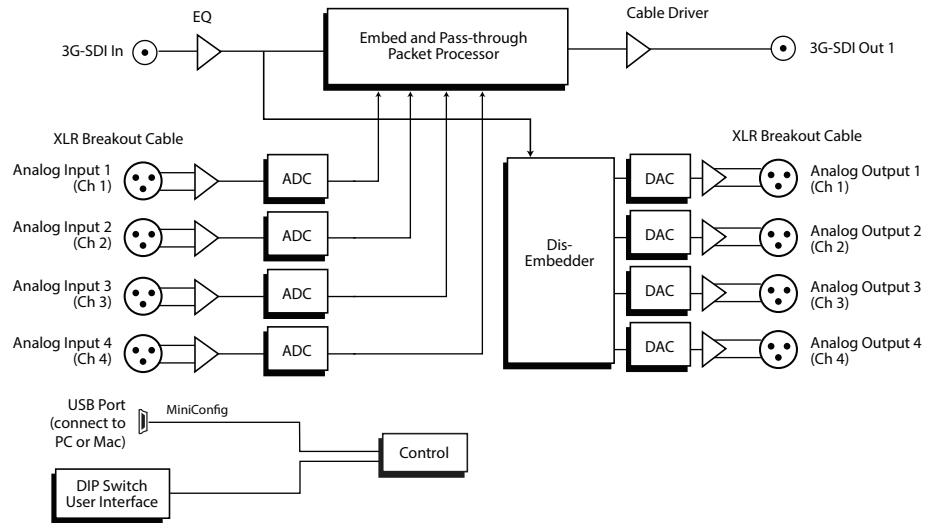

3G-AMA I/O Connections



Lock LED Status Indicators

- Off = No signal / no valid input
- Green = SD-SDI
- Red = HD-SDI
- Amber = 3G-SD

User Controls

DIP Switches

The 3G-AMA has an 8 position DIP switch accessible through a cut-out in the bottom of the unit. The DIP switches are used to configure the unit's audio embedding and disembedding, and control ancillary data.

Figure 1. 3G-AMA DIP Switches and Label

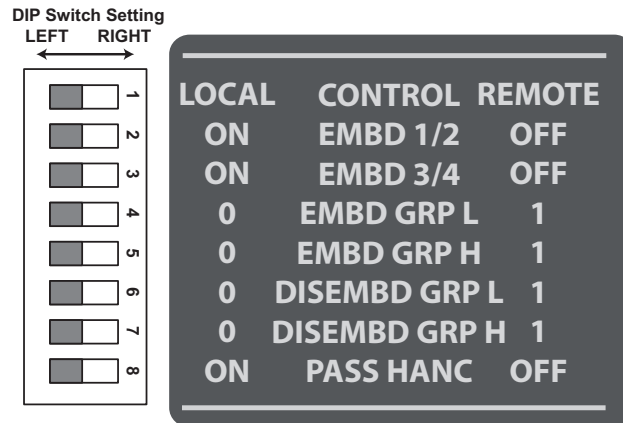

Factory default switch settings are all in the leftmost position.

The exact functions of the DIP switches are described in ["DIP Switch Settings" on page 8](#)

Mini-Config Control

The Mini-Config application can also be used to configure the unit's audio embedding and disembedding functions. Configuration set via Mini-Config is stored in the unit through subsequent power cycles.

Installing and using Mini-Config are described in ["USB Control and Setup—Using AJA Mini-Config" on page 10](#)

Installation

Typically, 3G-AMA installation consists of the following steps:

1. Ensure the converter is disconnected from power.
2. Connect video equipment to the converter BNCs.
3. Connect the breakout audio cable to the converter.
4. Connect audio equipment to the breakout cable.
5. Apply power to the converter (AJA power supply included).

6. The converter will now run using the default factory settings. If you wish to alter the factory settings you can either:
 - Change the DIP switch 2 - 8 settings.
 - or -
 - Install the AJA Mini-Config software on your computer,
 - attach the converter via USB,
 - change the DIP switch 1 setting to LOCAL, and
 - make your changes using the Mini-Config setup screens.

Breakout Cable Pinouts

Figure 2. AES Breakout Cable Illustration, XLR Connectors

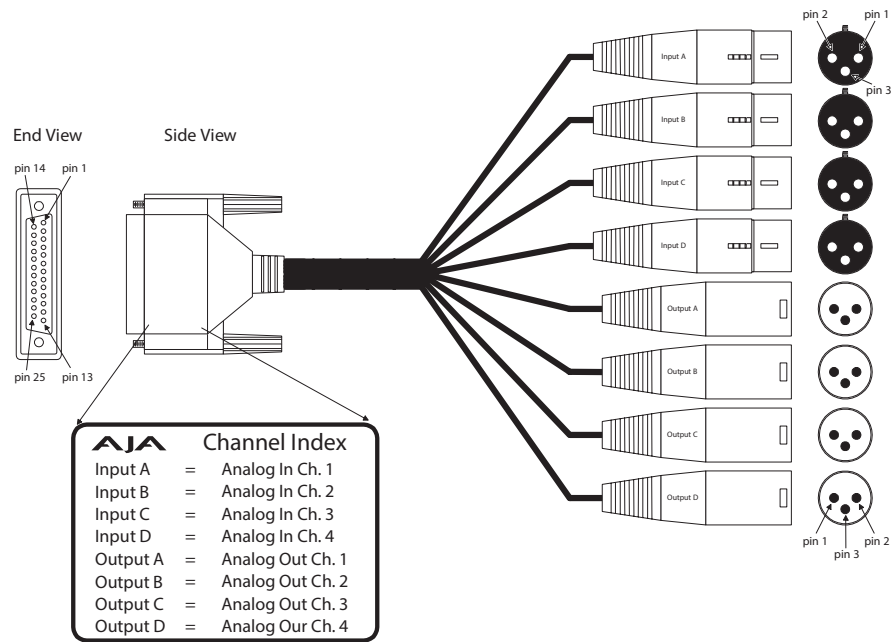

Table 1. XLR DB25 Breakout Cable Pinouts

Pin	Function	Pin, <connector>	Pin	Function	Pin, <connector>
1	In 4 +	2, XLR Input D	14	In 4 -	3, XLR Input D
2	In 4 GND	1, XLR Input D	15	In 3 +	2, XLR Input C
3	In 3 -	3, XLR Input C	16	In 3 GND	1, XLR Input C
4	In 2+	2, XLR Input B	17	In 2 -	3, XLR Input B
5	In 2 GND	1, XLR Input B	18	In 1 +	2, XLR Input A
6	In 1 -	3, XLR Input A	19	In 1 GND	1, XLR Input A
7	Out 4 +	2, XLR Output D	20	Out 4 -	3, XLR Output D
8	Out 4 GND	1, XLR Output D	21	Out 3 +	2, XLR Output C
9	Out 3 -	3, XLR Output C	22	Out 3 GND	1, XLR Output C
10	Out 2 +	2, XLR Output B	23	Out 2 -	3, XLR Output B
11	Out 2 GND	1, XLR Output B	24	Out 1 +	2, XLR Output A
12	Out 1 -	3, XLR Output A	25	Out 1 GND	1, XLR Output A
13	NC	NC			

Chapter 2 – Operation

Default Operational Settings

The 3G-AMA converter ships from the factory with the following configuration:

- Local (DIP switch) control.
- Input analog audio channels 1-4 are embedded to SDI output channels 1-4, overwriting any existing embedded audio.
- Input SDI embedded audio channels 1-4 are disembedded to analog audio output channels 1-4.
- All HANC packets pass from SDI input to output, except for embedded output audio channels 1-4.
- Analog audio levels are set to 0 dBfs = +24 dBu (Pro 1).

If these settings apply to your requirements, you can simply connect the video and audio input and output signal cables and power up the unit.

For other applications, you can configure the unit using its DIP switch settings, or by using the Mini-Config application and a PC or Mac via USB. Analog audio levels can only be set using Mini-Config.

DIP Switches

The 3G-AMA DIP switches configure the audio embedding and disembedding functions, and control ancillary data.

DIP Switch Settings

DIP switch settings used to configure various functions are described below.

Table 2. 3G-AMA DIP Switch Setting Descriptions

SWITCH	FUNCTION	DIP Set LEFT (default)	DIP Set RIGHT
1	Control	Selects Local (DIP), and blocks Mini-Config control.	Selects Remote (Mini-Config), and disables DIP switches 2-8.
2	Audio Embedding for Channels 1/2 (EMBD 1/2)	(ON) Overwrite or embed new channel 1/2 packets.	(OFF) If SW 8 is set to ON: Pass any channel 1/2 packets from input SDI. If SW 8 is set to OFF: Delete all packets from input SDI.
3	Audio Embedding for Channels 3/4 (EMDB 3/4)	(ON) Overwrite or embed new channel 3/4 packets.	(OFF) If SW 8 is set to ON: Pass any channel 3/4 packets from input SDI. If SW 8 is set to OFF: Delete all packets from input SDI.
4	Channel Mapping For Low Embedded Groups (EMBD GRP L)	Switches 4 and 5 operate together to determine Embedded channel mapping. 0 represents a Left DIP switch position 1 represents a Right DIP switch position Refer to " Embedded Output Channel Mapping " on page 9 for specific settings.	
5	Channel Mapping For High Embedded Groups (EMBD GRP H)		

SWITCH	FUNCTION	DIP Set LEFT (default)	DIP Set RIGHT
6	Channel Mapping For Low Disembedding Groups (DISEMBD GRP L)	Switches 6 and 7 operate together to determine Disembedded channel mapping. 0 represents a Left DIP switch position 1 represents a Right DIP switch position Refer to " Disembedded Input Channel Mapping " on page 10 for specific settings.	
7	Channel Mapping For High Disembedding Groups (DISEMBD GRP H)		
8	Pass or Drop HANC input packets. (PASS HANC)	(ON) All incoming HANC packets are passed unless the embedder settings above require all or part of them to be over-written.	(OFF) All incoming HANC packets are dropped before embedding any new audio packets. Embedder settings above determine all embedded audio output. Disembedding is not affected.

NOTE: 2048x1080p/psf 29.97 and 30 formats support a maximum of 8 channels of embedded audio. When one of these formats is present and embedding is turned on, the PASS HANC DIP switch will be ignored and all incoming packets will be dropped before embedding any new audio packets.

Switches 4 and 5 Channel Mapping For Embedded Groups

The following table shows how combinations of setting these two switches affects embedded channel mapping.

Table 3. Embedded Output Channel Mapping

DIP SW 4 EMBD GRP L	DIP SW 5 EMBD GRP H	Audio Input Channel	SDI Embedded Group	SDI Embedded Output Channel
Left (0)	Left (0)	1 →	1	1
		2 →		2
		3 →		3
		4 →		4
Right (1)	Left (0)	1 →	2	5
		2 →		6
		3 →		7
		4 →		8
Left (0)	Right (1)	1 →	3	9
		2 →		10
		3 →		11
		4 →		12
Right (1)	Right (1)	1 →	4	13
		2 →		14
		3 →		15
		4 →		16

Switches 6 and 7 Channel Mapping For Disembedded Groups

The following table shows how combinations of setting these two switches affects disembedding channel mapping.

Table 4. Disembedded Input Channel Mapping

DIP SW 6 DISEMBD GRP L	DIP SW 7 DISEMBD GRP H	SDI Embedded Input Group	SDI Embedded Input Channel	Audio Output Channel
Left (0)	Left (0)	1	1 →	1
			2 →	2
			3 →	3
			4 →	4
Right (1)	Left (0)	2	5 →	1
			6 →	2
			7 →	3
			8 →	4
Left (0)	Right (1)	3	9 →	1
			10 →	2
			11 →	3
			12 →	4
Right (1)	Right (1)	4	13 →	1
			14 →	2
			15 →	3
			16 →	4

USB Control and Setup—Using AJA Mini-Config

Your AJA Mini-Converter can be used right out of the box for some applications since it is designed to recognize inputs and perform standard actions automatically by default. However, to use its full capability, you must use AJA's Mini-Config software application for PCs and Macs. This same application can be used to update to new Mini-Converter software released by AJA.

NOTE: DIP switch 1 must be ON (Remote, Right) to permit Mini-Config control of the unit.

Acquiring Mini-Config

AJA's Mini-Config application is available for download from the AJA website.

To download the latest Mini-Config package, which includes the Mini-Config application, Mini-Converter firmware, and documentation, go to:

<https://www.aja.com/products/mini-converters/mini-config-software>

Select either the Windows or Mac icon to download the desired version.

Mini-Converter Documentation

Included with the Mini-Config package is a complete set of documentation for all Mini-Converters supported by Mini-Config. A .PDF of the *Installation and Operation Guide* for the currently connected Mini-Converter can be accessed from the Mini-Config UI via the **Help/Manual** drop-down menu.

Documentation for all AJA Mini-Converters that use Mini-Config can also be accessed directly in the Mini-Config download package Documentation folder, and via the Documentation icon available on the Mac installer.

Documentation (and firmware) included with the Mini-Config application are the versions available at the time of distribution. However, Mini-Converter software, firmware and documentation are updated regularly, so newer versions may exist.

To download the latest documentation for an individual Mini-Converter, go to:

<https://www.aja.com/category/mini-converters>

and navigate to the Support web page of that Mini-Converter.

Installing Mini-Config

PC Installation

NOTE: If you have an older version of Mini-Config software installed on your PC, AJA recommends uninstalling the older version before installing the current version.

To install Mini-Config on a Windows PC:

1. Download the application from the AJA website (select the Windows icon on the Mini-Config Support web page).
2. Open the AJA_MiniConfig.zip file
3. Double-click on the **MiniInstaller.msi** file.
4. A Setup Wizard will guide you through the installation.

Figure 3. Mini-Config PC Setup Wizard

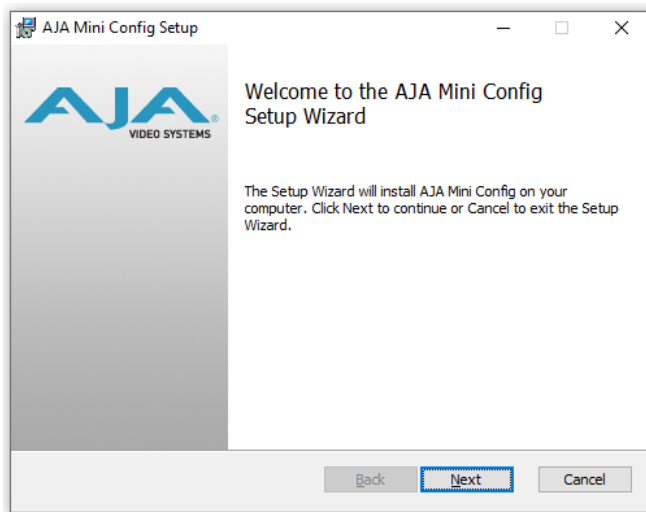

5. Click **Next** to begin. Answer the questions in the subsequent dialogues. When finished, an AJA Mini-Config shortcut will be installed on the desktop, and you will be able to locate the Mini-Config application in the AJA folder in the Programs listing.

NOTE: If the same version of the Mini-Config application already exists on the PC, a different Setup Wizard appears.

Figure 4. Mini-Config Setup Wizard, Reinstallation

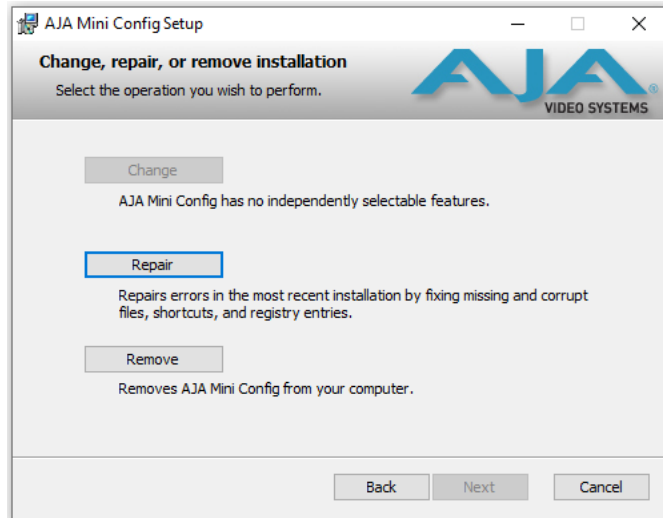

With this screen you can **Repair** (reinstall) or **Remove** (uninstall) Mini-Config on the PC.

Mac Installation

To install the application on a Mac:

NOTE: Intel and Apple Silicon (M1/M2) based CPUs are supported for use with AJA Mini-Config software.

1. Download the application from the AJA website (select the Apple icon on the Mini-Config Support web page).
2. Open the AJA_MiniConfig folder.
3. Double-click on the **AJAMiniConfig.dmg** file.
4. Answer the prompt and a utility program will be launched.

Figure 5. Mini-Config Mac Installer

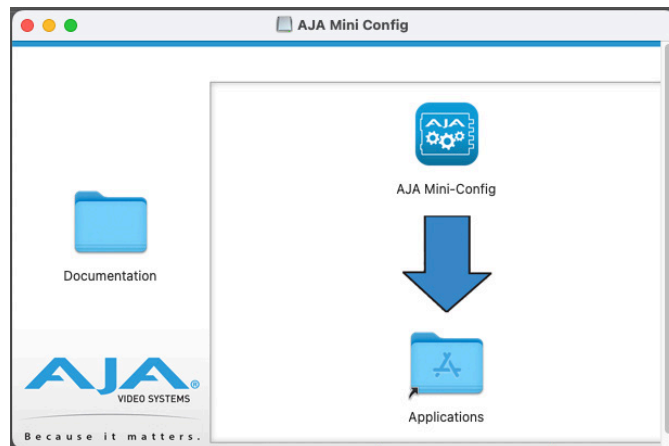

5. To complete the installation drag the **MiniConfig.app** icon to the Applications folder.

Running Mini-Config

Connect the Mini-Converter to the PC or Mac via the supplied USB cable. Connect the external power supply (supplied) to the Mini-Converter.

PC Startup

To run Mini-Config on a PC, double-click on the AJA Mini-Config icon on your desktop, or open the AJA folder in the program list and click on the AJA Mini-Config application located inside the Mini-Config folder.

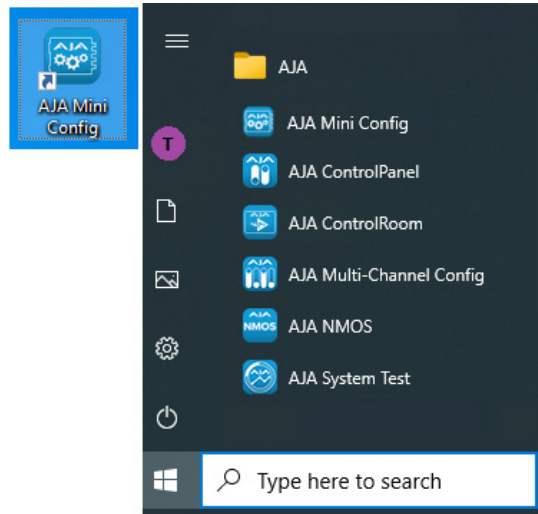

Mac Startup

To run Mini-Config on a Mac, open the Applications folder and locate the AJA Mini-Config application. Double-click the application to launch it.

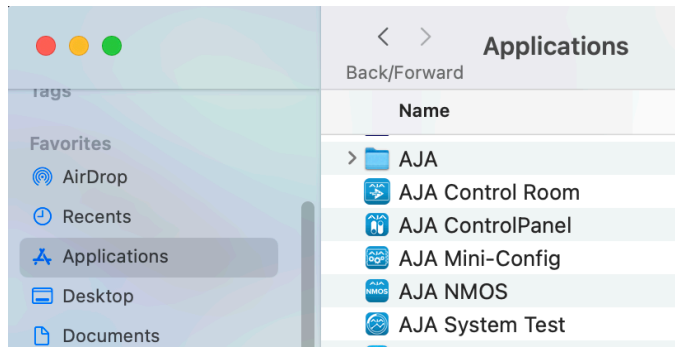

Saving Setups

A **File** drop down menu on the Mini-Config application bar (similar for Mac and PC) allows you to save the current state of the Mini-Converter to a preset file for later recall.

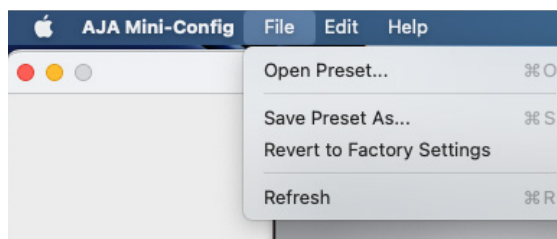

Using this feature you can set up the converter for different applications, storing each configuration (**Save Preset As...**) with a unique name for easy recall (**Open Preset...**).

A **Revert to Factory Settings** menu item similarly allows you to change the settings back to AJA's factory defaults.

Operating Mini-Config

The Mini-Config application provides a graphic interface for viewing settings and updating software. It consists of an information area at the top that shows the available Mini-Converters attached to the computer via USB, with a graphical rendering of the selected Mini-Converter showing all the connectors and their current state.

Colored text next to the connectors indicates the signal type and what the Mini-Converter is doing:

- Blue text indicates the values automatically selected
- Black text indicates values that you have manually selected
- Red text indicates the Mini-Converter is not detecting a signal, or cannot operate with the current user settings.

NOTE: Even if no output device is detected, the SDI connector text still shows the signal it is outputting.

NOTE: Configuration settings in red will change based on the attached output device as well as input signals. For improved accuracy and reliability, you should configure the Mini-Converter only when the target output device is attached and input signals are supplied at the inputs.

Screens are virtually the same on both PC and Mac, with subtle differences that reflect the general look of the platform environment.

Figure 6. Example Mini-Config Screen

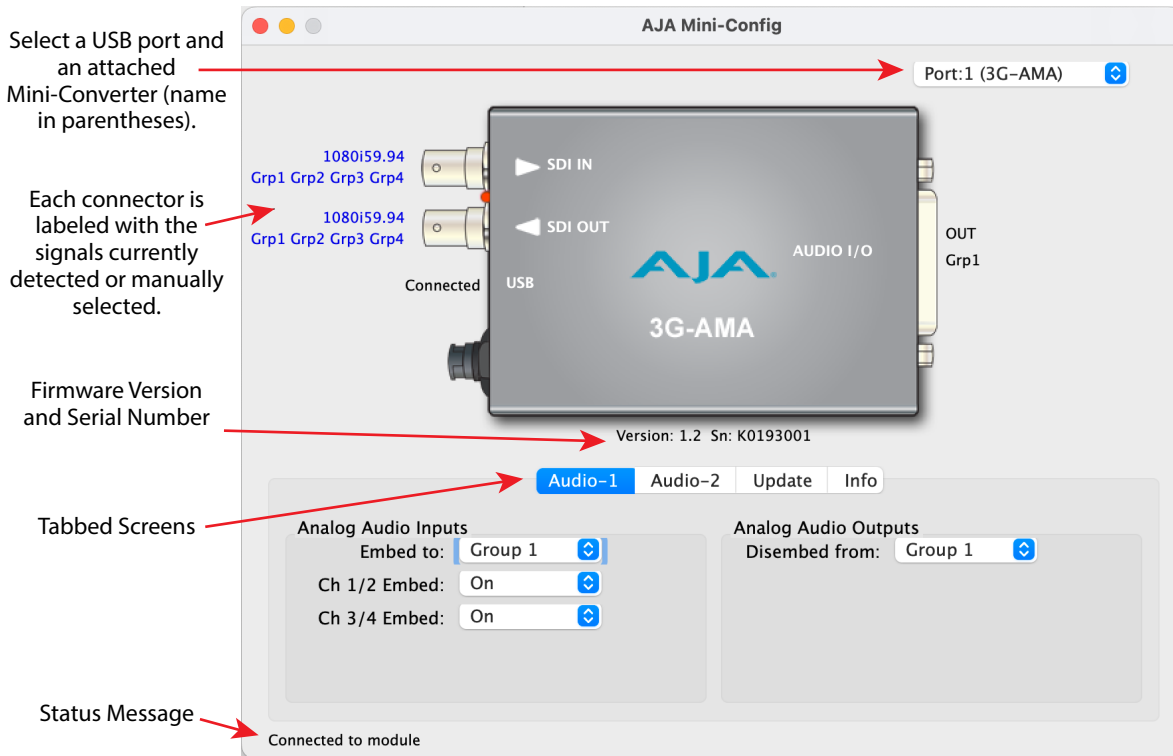

Selecting a Mini-Converter with the pulldown menu causes this application to connect to the selected converter. The graphic of Mini-Converter and text below it provides:

- Type of converter
- Firmware version

- Serial number of the unit.

A status field at the bottom of the screen shows if your application is connected and communicating with the Mini-Converter.

When configuring the Mini-Converter, select it from the top pulldown, view the current settings and change any values. Making a change communicates that new value to the Mini-Converter's non-volatile memory.

Tabbed Screens

The Tabs delineate control screens with groups of controls for each type of task to be performed.

The controls for the actual configuration parameters are specific to each Mini-Converter type. When you Click on any of the tab buttons, the pane below the tabs will change to match your tab selection. Any changes you make are immediately applied and will be saved, overwriting previous settings.

Audio-1 Tab Screen

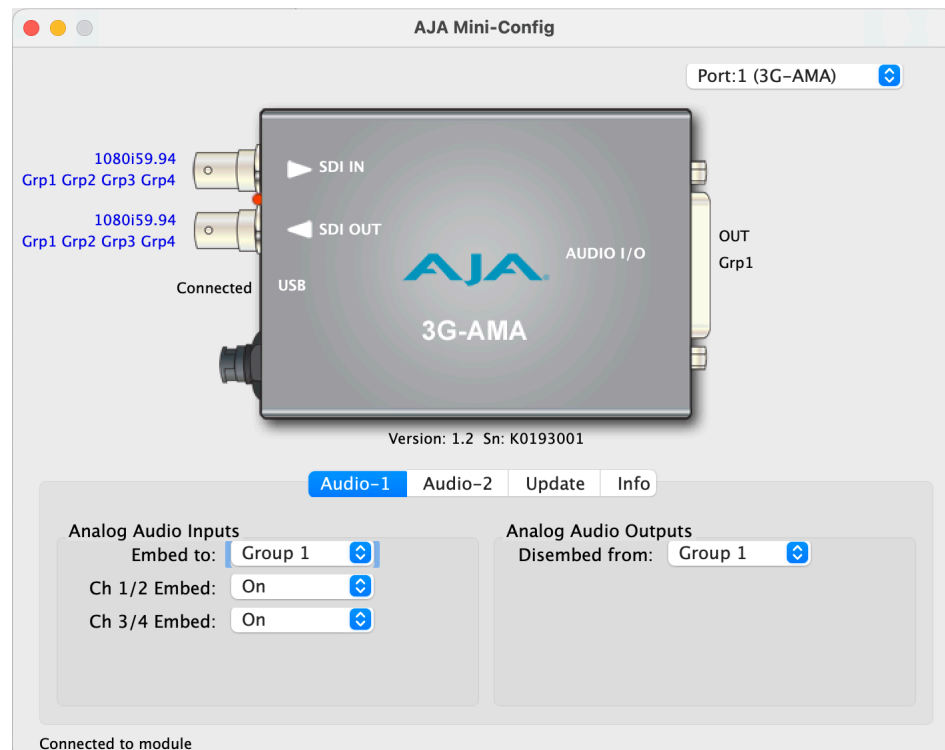

Click on the Audio-1 tab to view and make changes to the audio embedding and disembedding settings.

Analog Audio Inputs

Embed to:

Choose which SDI embedded audio group will embed incoming analog audio:

- Group 1 (Ch 1-4), Group 2 (Ch 5-8), Group 3 (Ch 9-12), or Group 4 (Ch 13-16).

Ch1-2 Embed:

- Selecting On embeds the analog audio Ch 1/2 pair in the first two channels of the Group selected above.

Ch 3-4 Embed:

- Selecting On embeds the analog audio Ch 3/4 pair in the last two channels of the Group selected above.

Analog Audio Outputs

Disembled from:

Choose which SDI embedded audio group will disembled its audio and send it to the four analog audio outputs:

- Group 1 (Ch 1-4), Group 2 (Ch 5-8), Group 3 (Ch 9-12), or Group 4 (Ch 13-16).

Audio-2 Tab Screen

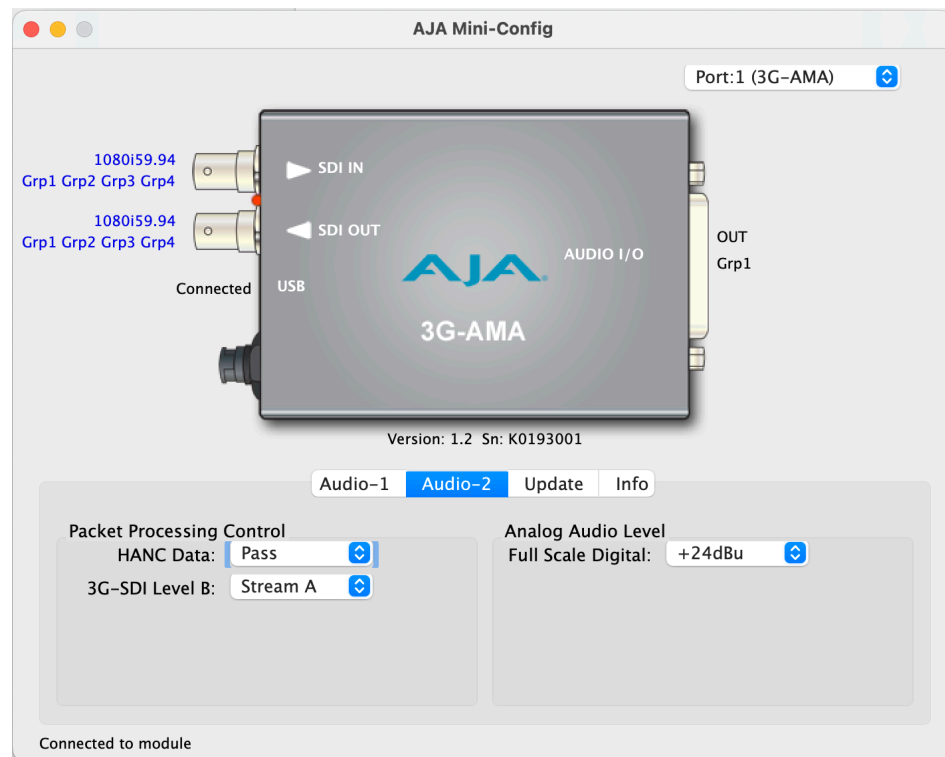

Click on the Audio-2 tab to view and make changes to the packet processing and audio level settings.

Packet Processing Control

HANC Data:

- Pass - All incoming HANC packets are passed unless the embedder settings require all or part of them to be over-written.
- Remove - If incoming HANC packets are dropped before embedding any new audio packets. The embedder settings determine all embedded audio output. Disembedding is not affected.

NOTE: 2048x1080p/psf 29.97 and 30 formats support a maximum of 8 channels of embedded audio. When one of these formats is present and embedding is turned on, the PASS HANC setting will be ignored and all incoming packets will be dropped before embedding any new audio packets.

3G-SDI Level B:

For 3G Level B signals, selects either the 16 audio channels of input Stream A or the 16 channels of input Stream B for disembedding. This setting also controls whether output Stream A or output Stream B will receive embedded audio. This control has no effect if a 3G Level B signal is not detected.

Analog Audio Levels

- Select from Full Scale Digital settings of +24, +18, +15 (professional), or +12dBu (consumer).

About Audio Levels

Professional audio equipment has much higher levels than consumer equipment: a 0 VU reading corresponds to +4 dBu. Connecting a professional +4 dBu device to a consumer audio input (-7 to -8 dBu) may produce overloading, whereas the output of a consumer device probably does not have sufficient power to drive a professional audio input. With consumer and semi-professional audio equipment, a VU reading of 0 dB is typically referenced to -10 dBV, which is equivalent to -7.78 dBu.

Update Tab Screen

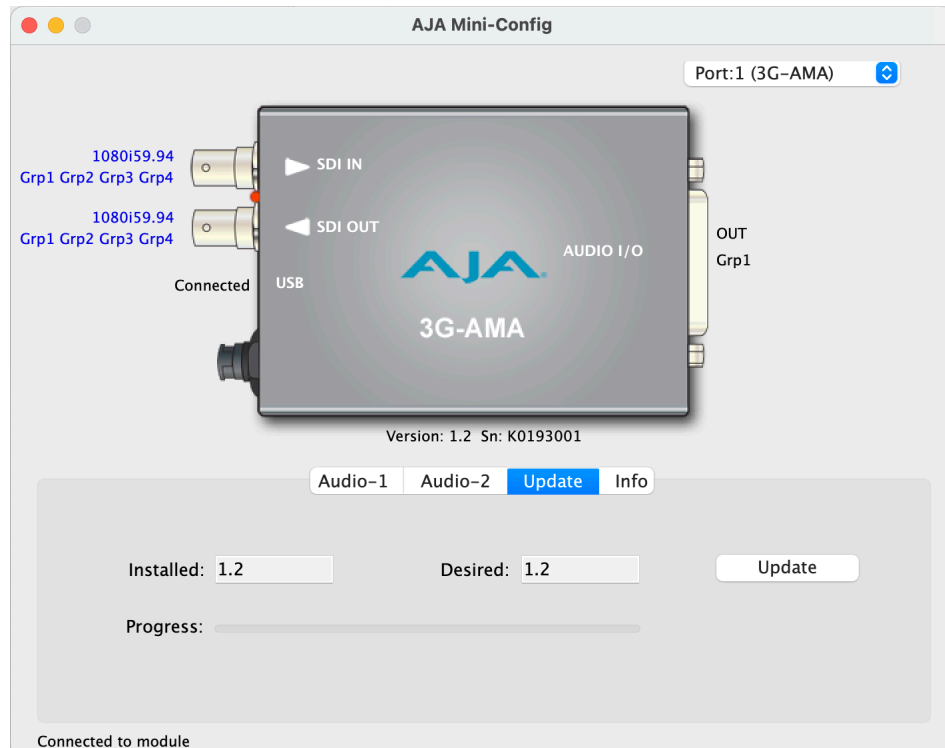

Use this Update tab screen to view the software version currently installed on the converter or install new software.

NOTE: When discussing Mini-Converters, “Firmware” is software that will be stored in the Mini-Converter’s non-volatile memory and used when it is powered up. This is something different than the Mini-Config application software. The version numbers shown in the Update screen refer only to the firmware.

Installed

This field shows the version of the firmware currently installed inside the Mini-Converter.

Desired

This field shows the version of firmware embedded in the Mini-Config application which you can install into the Mini-Converter by clicking the Update button.

Update

This button initiates a software update operation loading the “Desired” version of firmware into the Mini-Converter’s non-volatile memory.

Progress

This indicator bar shows the progress of firmware installation.

See ["Acquiring Mini-Config" on page 10](#) and ["Installing Mini-Config" on page 11](#) for more information.

Info Tab Screen

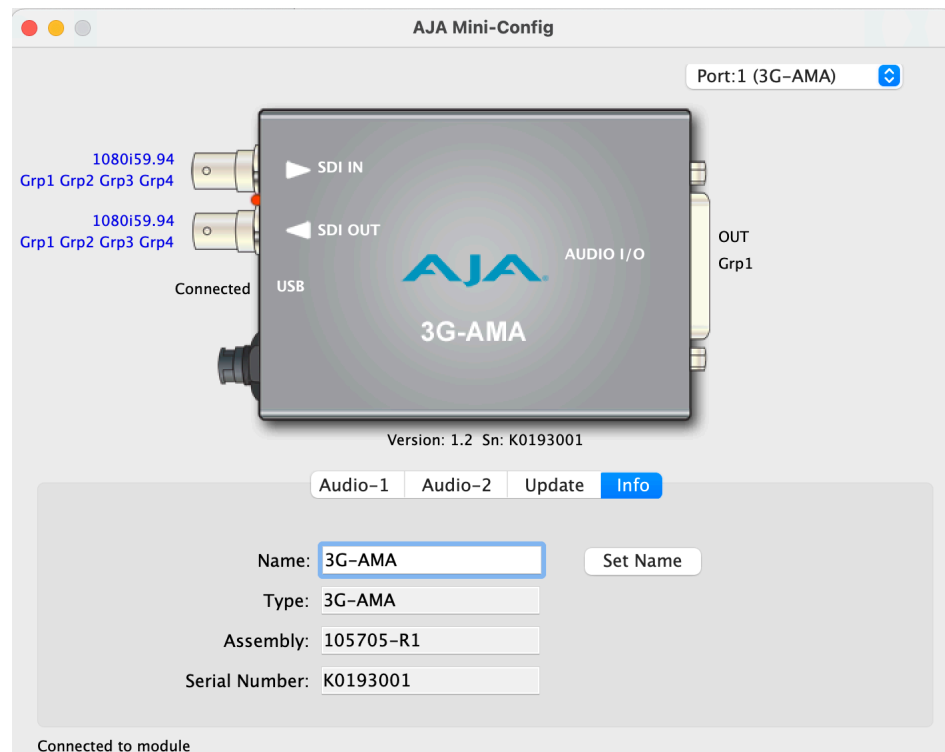

This screen provides basic information about the Mini-Converter. This information is mostly useful when calling AJA Support for service or technical support.

Name

This field allows you to give your Mini-Converter a name. This can be useful if you have several Mini-Converters attached to a Mac/PC via USB so you can distinguish between them easily (especially if they're the same model). Click Set Name to apply new name.

Type

This is the factory set model name of the Mini-Converter.

Assembly

This is the factory assembly number.

NOTE: Some newly manufactured Mini-Converters may not be backwards compatible with older firmware and Mini-Config versions. It is highly recommended that you update the firmware to avoid any potential issues. Please check the current Release Notes to confirm that the Assembly number is compatible with any older firmware or Mini-Config versions.

Serial Number

This is the factory set unique serial number of your Mini-Converter. If you ever call AJA Support for service, you may be asked for this number.

Appendix A – Specifications

3G-AMA Tech Specs

Video Formats

- (2K) 2048 x 1080p
- (2K) 2048 x 1080PsF
- (HD) 1920 x 1080p
- (HD) 1920 x 1080PsF
- (HD) 1920 x 1080i
- (HD) 1280 x 720p
- (SD) 720 x 576i
- (SD) 720 x 480i

Video Input Formats

- 1x 3 Gb SDI (level A or B)
 - (2K) 2048 x 1080p 23.98, 24, 25, 29.97, 30, 50, 59.94, 60
 - (2K) 2048 x 1080PsF 23.98, 24, 25, 29.97, 30
 - (HD) 1920 x 1080p 23.98, 24, 25, 29.97, 30, 50, 59.94, 60
 - (HD) 1920 x 1080PsF 23.98, 24, 25, 29.97, 30
 - (HD) 1920 x 1080i 50, 59.94, 60
 - (HD) 1280 x 720p 50, 59.94, 60
- 1x 1.5 Gb SDI
 - (2K) 2048 x 1080p 23.98, 24, 25, 29.97, 30
 - (2K) 2048 x 1080PsF 23.98, 24, 25, 29.97, 30
 - (HD) 1920 x 1080p 23.98, 24, 25, 29.97, 30
 - (HD) 1920 x 1080PsF 23.98, 24, 25, 29.97, 30
 - (HD) 1920 x 1080i 50, 59.94, 60
 - (HD) 1280 x 720p 23.98, 24, 25, 29.97, 30, 50, 59.94, 60
- 1x 270 Mb SDI
 - (SD) 625i 50
 - (SD) 525i 59.94

Video Output Formats

- Video Out is a delayed, reclocked version of Video In, at same frame rate, etc. Video Out is undefined when no input.
- Video Latency, time measured between video input and video output connector:
 - 3G level A = 3.2 usec
 - 3G level B = 6.1 usec
 - HD (1.5 Gb) = 6.3 usec
 - SD (270 Mb) = 17.2 usec

Video Input Digital

- 1x 3G-SDI BNC, SMPTE-259/292/372/424

Video Output Digital

- 1x 3G-SDI BNC, SMPTE-259/292/372/424

Audio Inputs and Outputs

- Balanced Analog Audio, 1x 25 pin D female connector on converter, 4-Channels in, 4-Channels out.
- Breakout cable provided with 1x 25 pin D male connector:
 - 4x XLR female input breakout connectors
 - 4x XLR male output breakout connectors

Digital Audio Converters

- 24-bit

Embedded Audio

- SMPTE 272M (SD): 20-bit, 48 KHz synchronous
- SMPTE 299M (3G/HD): 24-bit, 48 KHz synchronous
- Incoming embedded audio can be passed, removed, or overridden.
- Up to 16 channels supported.

NOTE: 2048 x 1080p/PsF 29.97 and 30 formats support a maximum of 8-Channels embedded audio.

Embed Path Audio Latency, time measured between audio input and video output connector:

- 1100 usec

Disembed Path Audio Latency, time measured between video input and audio output connector:

- 1200 usec

Analog Audio Levels

Configured via Mini-Config software:

- Pro 1: 0 dBfs = +24 dBu
- Pro 2: 0 dBfs = +18 dBu
- Pro 3: 0 dBfs = +15 dBu
- Consumer 1: 0 dBfs = +12 dBu

User Controls

- External DIP switch
- USB port used with Mini-Config software application to configure device via PC/Mac

Size (w x d x h)

- 5.8" x 3.1" x 1.0" (147.32 x 78.74 x 25.4 mm)

Power

- +5-20VDC, 5 watts. power supply required, included with purchase

Environment

- Safe Operating Temperature: 0 to 40 C (32 to 104 F)
- Safe Storage Temperature (Power OFF): -40 to 60 C (-40 to 140 F)
- Operating Relative Humidity: 10-90% noncondensing
- Operating Altitude: <3,000 meters (<10,000 feet)

Appendix B – Safety and Compliance

Federal Communications Commission (FCC) Compliance Notices

Class A Interference Statement

This equipment has been tested and found to comply with the limits for a Class A digital device, pursuant to Part 15, Subpart B of the FCC Rules. These limits are designed to provide reasonable protection against harmful interference in a residential installation. This equipment generates, uses, and can radiate radio frequency energy and, if not installed and used in accordance with the instructions, may cause harmful interference to radio communications. However, there is no guarantee that interference will not occur in a particular installation. If this equipment does cause harmful interference to radio or television reception, which can be determined by turning the equipment off and on, the user is encouraged to try to correct the interference by one or more of the following measures:

- Reorient or relocate the receiving antenna.
- Increase the separation between the equipment and receiver.
- Connect the equipment into an outlet on a circuit different from that to which the receiver is connected.
- Consult the dealer or an experienced radio/TV technician for help.

FCC Caution

This device complies with Part 15 of the FCC Rules. Operation is subject to the following two conditions: (1) This device may not cause harmful interference, and (2) this device must accept any interference received, including interference that may cause undesired operation.

Canadian ICES Statement

Canadian Department of Communications Radio Interference Regulations

This digital apparatus does not exceed the Class A limits for radio-noise emissions from a digital apparatus as set out in the Radio Interference Regulations of the Canadian Department of Communications. This Class A digital apparatus complies with Canadian ICES-003.

Règlement sur le brouillage radioélectrique du ministère des Communications

Cet appareil numérique respecte les limites de bruits radioélectriques visant les appareils numériques de classe A prescrites dans le Règlement sur le brouillage radioélectrique du ministère des Communications du Canada. Cet appareil numérique de la Classe A est conforme à la norme NMB-003 du Canada.

European Union, European Free Trade Association (EFTA) and United Kingdom Regulatory Compliance

This equipment may be operated in the countries that comprise the member countries of the European Union, European Free Trade Association and the United Kingdom. These countries, listed in the following paragraph, are referred to as The European Community throughout this document:

AUSTRIA, BELGIUM, BULGARIA, CROATIA, CZECH REPUBLIC, DENMARK, ESTONIA, FINLAND, FRANCE, GERMANY, GREECE, HUNGARY, ICELAND, IRELAND, ITALY, LATVIA, LIECHTENSTEIN, LITHUANIA, LUXEMBOURG, MALTA, NETHERLANDS, NORWAY, POLAND, PORTUGAL, REPUBLIC OF CYPRUS, ROMANIA, SLOVAK REPUBLIC, SLOVENIA, SPAIN, SWEDEN, SWITZERLAND, UNITED KINGDOM

Declaration of Conformity

Marking by these symbols indicates compliance with the Essential Requirements of the EMC Directive of the European Union 2014/30/EU.



This equipment meets the following conformance standards:

Safety

EN 62368-1: 2014 + A11 (T-Mark License)
IEC 62368-1: 2014 (CB Scheme Certificate)

Emissions

EN 55032: 2015 + A11: 2020, CISPR 32: 2015
EN 61000-3-2: 2014, EN 61000-3-3: 2013

Immunity

EN 55035: 2017 + A11: 2020, EN 61000-4-2: 2009, EN 61000-4-3: 2006+ A1: 2008 +
A2: 2010, EN 61000-4-4: 2012, EN 61000-4-5: 2014/A1: 2017, EN 61000-4-6: 2014,
EN 61000-4-8: 2010, EN 61000-4-11: 2020

Environments: E2, E3 and E4

The product is also licensed for additional country specific standards as required for the International Marketplace.



Warning! This is a Class A product. In a domestic environment, this product may cause radio interference, in which case, the user may be required to take appropriate measures.

Achtung! Dieses ist ein Gerät der Funkstörgrenzwertklasse A. In Wohnbereichen können bei Betrieb dieses Gerätes Rundfunkstörungen auftreten, in welchen Fällen der Benutzer für entsprechende Gegenmaßnahmen verantwortlich ist.

Attention! Ceci est un produit de Classe A. Dans un environnement domestique, ce produit risque de créer des interférences radioélectriques, il appartiendra alors à l'utilisateur de prendre les mesures spécifiques appropriées.

Recycling Notice



This symbol on the product or its packaging indicates that this product must not be disposed of with your other household waste. Instead, it is your responsibility to dispose of your waste equipment by handing it over to a designated collection point for the recycling of waste electrical and electronic equipment. The separate collection and recycling of your waste equipment at the time of disposal will help conserve natural resources and ensure that it is recycled in a manner that protects human health and the environment. For more information about where you can drop off your waste for recycling, please contact your local authority, or where you purchased your product.

Korea KCC Compliance Statement

사용자안내문

이 기기는 업무용 환경에서 사용할 목적으로 적합성평가를 받은 기기로서 가정용 환경에서 사용하는 경우 전파간섭의 우려가 있습니다.

Taiwan Compliance Statement

警告使用者：
這是甲類的資訊產品，在居住的環境中使用時，可能會造成射頻干擾，在這種情況下，使用者會被要求採取某些適當的對策。

This is a Class A product based on the standard of the Bureau of Standards, Metrology and Inspection (BSMI) CNS 13438, Class A. In a domestic environment this product may cause radio interference in which case the user may be required to take adequate measures.

Japan Compliance Statement

この装置は、クラスA情報技術装置です。この装置を家庭環境で使用すると電波妨害を引き起こすことがあります。この場合には使用者が適切な対策を講ずるよう要求されることがあります。 VCCI-A

This is a Class A product based on the standard of the VCCI Council (VCCI 32: 2016). If this equipment is used in a domestic environment, radio interference may occur, in which case, the user may be required to take corrective actions.

Translated Warning and Caution Messages

The following caution statements, warning conventions, and warning messages apply to this product and manual.



Warning Symbol



Caution Symbol

Before Operation Please Read These Instructions



Warning! Read and follow all warning notices and instructions marked on the product or included in the documentation.

Avertissement! Lisez et conformez-vous à tous les avis et instructions d'avertissement indiqués sur le produit ou dans la documentation.

Warnung! Lesen und befolgen Sie die Warnhinweise und Anweisungen, die auf dem Produkt angebracht oder in der Dokumentation enthalten sind.

¡Advertencia! Lea y siga todas las instrucciones y advertencias marcadas en el producto o incluidas en la documentación.

Aviso! Leia e siga todos os avisos e instruções assinalados no produto ou incluídos na documentação.

Avviso! Leggere e seguire tutti gli avvisi e le istruzioni presenti sul prodotto o inclusi nella documentazione.



Warning! Do not use this device near water and clean only with a dry cloth.

Avertissement! N'utilisez pas cet appareil près de l'eau et nettoyez-le seulement avec un tissu sec.

Warnung! Das Gerät nicht in der Nähe von Wasser verwenden und nur mit einem trockenen Tuch säubern.

¡Advertencia! No utilice este dispositivo cerca del agua y límpielo solamente con un paño seco.

Aviso! Não utilize este dispositivo perto da água e limpe-o somente com um pano seco.

Avviso! Non utilizzare questo dispositivo vicino all'acqua e pulirlo soltanto con un panno asciutto.



Warning! Do not block any ventilation openings. Install in accordance with the manufacturer's instructions.

Avertissement! Ne bloquez aucune ouverture de ventilation. Suivez les instructions du fabricant lors de l'installation.

Warnung! Die Lüftungsöffnungen dürfen nicht blockiert werden. Nur gemäß den Anweisungen des Herstellers installieren.

¡Advertencia! No bloquee ninguna de las aberturas de la ventilación. Instale de acuerdo con las instrucciones del fabricante.

Aviso! Não obstrua nenhuma das aberturas de ventilação. Instale de acordo com as instruções do fabricante.

Avviso! Non ostruire le aperture di ventilazione. Installare in conformità con le istruzioni del fornitore.



Warning! Do not install near any heat sources such as radiators, heat registers, stoves, or other apparatus (including amplifiers) that produce heat.

Avertissement! N'installez pas l'appareil près d'une source de chaleur telle que des radiateurs, des bouches d'air de chauffage, des fourneaux ou d'autres appareils (amplificateurs compris) qui produisent de la chaleur.

Warnung! Nicht in der Nähe von Wärmequellen wie Heizkörpern, Heizregistern, Öfen oder anderen Wärme erzeugenden Geräten (einschließlich Verstärkern) aufstellen.

¡Advertencia! No instale cerca de fuentes de calor tales como radiadores, registros de calor, estufas u otros aparatos (incluidos amplificadores) que generan calor.

Aviso! Não instale perto de nenhuma fonte de calor tal como radiadores, saídas de calor, fogões ou outros aparelhos (incluindo amplificadores) que produzam calor.

Avviso! Non installare vicino a fonti di calore come termosifoni, diffusori di aria calda, stufe o altri apparecchi (amplificatori compresi) che emettono calore.



Warning! Do not defeat the safety purpose of the polarized or grounding-type plug. A polarized plug has two blades with one wider than the other. A grounding type plug has two blades and a third grounding prong. The wide blade or the third prong are provided for your safety. If the provided plug does not fit into your outlet, consult an electrician for replacement of the obsolete outlet.

Avertissement! La sécurité de la prise polarisée ou de la prise de type mise à la terre ne doit en aucun cas être empêchée de fonctionner. Une prise polarisée a deux broches, l'une étant plus large que l'autre. Une prise de type mise à la terre a deux broches et une troisième broche pour la mise à la terre. La broche large ou la troisième broche sont fournies pour votre sécurité. Si la prise fournie ne s'insère pas dans votre prise femelle, consultez un électricien pour le remplacement de la prise femelle obsolète.

Warnung! Der Sicherheitszweck des gepolten bzw. Schukosteckers ist zu berücksichtigen. Ein gepolter Stecker verfügt über zwei Pole, von denen einer breiter als der andere ist. Ein Schukostecker verfügt neben den zwei Polen noch über einen dritten Pol zur Erdung. Der breite Pol bzw. der Erdungspol dienen der Sicherheit. Wenn der zur Verfügung gestellte Stecker nicht in Ihren Anschluss passt, konsultieren Sie einen Elektriker, um den veralteten Anschluss zu ersetzen.

¡Advertencia! No eche por tierra la finalidad del tipo de enchufe polarizado con conexión a tierra. Un enchufe polarizado tiene dos espigas, una más ancha que la otra. Un enchufe con conexión a tierra tiene dos espigas iguales y una tercera espiga que sirve para la conexión a tierra. La espiga ancha, o la tercera espiga, sirven para su seguridad. Si el enchufe suministrado no encaja en el tomacorriente, consulte con un electricista para reemplazar el tomacorriente obsoleto.

Aviso! Não anule a finalidade da segurança da ficha polarizada ou do tipo ligação terra. Uma ficha polarizada tem duas lâminas sendo uma mais larga do que a outra. Uma ficha do tipo de ligação à terra tem duas lâminas e um terceiro terminal de ligação à terra. A lâmina larga ou o terceiro terminal são fornecidos para sua segurança. Se a ficha fornecida não couber na sua tomada, consulte um electricista para a substituição da tomada obsoleta.

Avviso! Non compromettere la sicurezza della spina polarizzata o con messa a terra. Una spina polarizzata ha due spinotti, di cui uno più largo. Una spina con messa a terra ha due spinotti e un terzo polo per la messa a terra. Lo spinotto largo o il terzo polo sono forniti per motivi di sicurezza. Se la spina fornita non si inserisce nella presa di corrente, contattare un elettricista per la sostituzione della presa obsoleta.



Warning! Since the Mains plug is used as the disconnection for the device, it must remain readily accessible and operable.

Avertissement! Puisque la prise principale est utilisée pour débrancher l'appareil, elle doit rester aisément accessible et fonctionnelle.

Warnung! Da der Netzstecker als Trennvorrichtung dient, muss er stets zugänglich und funktionsfähig sein.

¡Advertencia! Puesto que el enchufe de la red eléctrica se utiliza como dispositivo de desconexión, debe seguir siendo fácilmente accesible y operable.

Aviso! Dado que a ficha principal é utilizada como a desconexão para o dispositivo, esta deve manter-se prontamente acessível e funcional.

Avviso! Poiché il cavo di alimentazione viene usato come dispositivo di sconnessione, deve rimanere prontamente accessibile e operabile.



Warning! Protect the power cord from being walked on or pinched particularly at plugs, convenience receptacles, and the point where they exit from the device.

Avertissement! Protégez le cordon d'alimentation pour que l'on ne marche pas dessus ou qu'on le pince, en particulier au niveau des prises mâles, des réceptacles de convenance, et à l'endroit où il sort de l'appareil.

Warnung! Vermeiden Sie, dass auf das Netzkabel getreten oder das Kabel geknickt wird, insbesondere an den Steckern, den Steckdosen und am Kabelausgang am Gerät.

¡Advertencia! Proteja el cable de energía para que no se le pise ni apriete, en especial cerca del enchufe, los receptáculos de conveniencia y el punto del que salen del equipo.

Aviso! Proteja o cabo de alimentação de ser pisado ou de ser comprimido particularmente nas fichas, em tomadas de parede de conveniência e no ponto de onde sai do dispositivo.

Avviso! Proteggere il cavo di alimentazione in modo che nessuno ci cammini sopra e che non venga schiacciato soprattutto in corrispondenza delle spine e del punto in cui esce dal dispositivo.



Warning! Unplug this device during lightning storms or when unused for long periods of time.

Avertissement! Débranchez cet appareil pendant les orages avec éclairsou s'il est inutilisé pendant de longues périodes.

Warnung! Das Gerät ist bei Gewitterstürmen oder wenn es über lange Zeiträume ungenutzt bleibt vom Netz zu trennen.

¡Advertencia! Desenchufe este dispositivo durante tormentas eléctricas o cuando no se lo utilice por largos periodos del tiempo.

Aviso! Desconecte este dispositivo da tomada durante trovoadas ou quando não é utilizado durante longos períodos de tempo.

Avviso! Utilizzare soltanto i collegamenti e gli accessori specificati e/o venduti dal produttore, quali il treppiedi e l'esoscheletro.



Warning! Refer all servicing to qualified service personnel. Servicing is required when the device has been damaged in any way, such as power-supply cord or plug is damaged, liquid has been spilled or objects have fallen into the device, the device has been exposed to rain or moisture, does not operate normally, or has been dropped.

Avertissement! Référez-vous au personnel de service qualifié pour tout entretien. L'entretien est exigé quand l'appareil a été endommagé de quelque manière que ce soit, par exemple lorsque le cordon d'alimentation ou la prise sont endommagés, que du liquide a été versé ou des objets sont tombés dans l'appareil, que l'appareil a été exposé à la pluie ou à l'humidité, ne fonctionne pas normalement ou est tombé.

Warnung! Das Gerät sollte nur von qualifizierten Fachkräften gewartet werden. Eine Wartung ist fällig, wenn das Gerät in irgendeiner Weise beschädigt wurde, wie bei beschädigtem Netzkabel oder Netzstecker, falls Flüssigkeiten oder Objekte in das Gerät gelangen, das Gerät Regen oder Feuchtigkeit ausgesetzt wurde, nicht ordnungsgemäß funktioniert oder fallen gelassen wurde.

¡Advertencia! Consulte al personal calificado por cuestiones de reparación. El servicio de reparación se requiere cuando el dispositivo ha recibido cualquier tipo de daño, por ejemplo cable o espigas dañadas, se ha derramado líquido o se han caído objetos dentro del dispositivo, el dispositivo ha sido expuesto a la lluvia o humedad, o no funciona de modo normal, o se ha caído.

Aviso! Remeta todos os serviços de manutenção para o pessoal de assistência qualificado. A prestação de serviços de manutenção é exigida quando o dispositivo foi danificado mediante qualquer forma, como um cabo de alimentação ou ficha que se encontra danificado/a, quando foi derramado líquido ou caíram objectos sobre o dispositivo, quando o dispositivo foi exposto à chuva ou à humidade, quando não funciona normalmente ou quando foi deixado cair.

Avviso! Fare riferimento al personale qualificato per tutti gli interventi di assistenza. L'assistenza è necessaria quando il dispositivo è stato danneggiato in qualche modo, ad esempio se il cavo di alimentazione o la spina sono danneggiati, è stato rovesciato del liquido è stato rovesciato o qualche oggetto è caduto nel dispositivo, il dispositivo è stato esposto a pioggia o umidità, non funziona correttamente o è caduto



Warning! Do not open the chassis. There are no user-serviceable parts inside. Opening the chassis will void the warranty unless performed by an AJA service center or licensed facility.

Avertissement! Ne pas ouvrir le châssis. Aucun élément à l'intérieur du châssis ne peut être réparé par l'utilisateur. La garantie sera annulée si le châssis est ouvert par toute autre personne qu'un technicien d'un centre de service ou d'un établissement agréé AJA.

Warnung! Öffnen Sie das Gehäuse nicht. Keine der Geräteteile können vom Benutzer gewartet werden. Durch das Öffnen des Gehäuses wird die Garantie hinfällig, es sei denn, solche Wartungsarbeiten werden in einem AJA-Service-Center oder einem lizenzierten Betrieb vorgenommen.

¡Advertencia! No abra el chasis. El interior no contiene piezas reparables por el usuario. El abrir el chasis anulará la garantía a menos que se lo haga en un centro de servicio AJA o en un local autorizado.

Advertência! Não abra o chassi. Não há internamente nenhuma peça que permita manutenção pelo usuário. Abrir o chassi anula a garantia, a menos que a abertura seja realizada por uma central de serviços da AJA ou por um local autorizado.

Avvertenza! Non aprire lo chassis. All'interno non ci sono parti riparabili dall'utente. L'apertura dello chassis invaliderà la garanzia se non viene effettuata da un centro ufficiale o autorizzato AJA.



Warning! Disconnect the external AC power supply line cord(s) from the mains power before moving the unit.

Avertissement! Retirez le ou les cordons d'alimentation en CA de la source d'alimentation principale lorsque vous déplacez l'appareil.

Warnung! Trennen Sie die Wechselstrom-Versorgungskabel vom Netzstrom, bevor Sie das Gerät verschieben.

¡Advertencia! Cuando mueva la unidad desenchufe de la red eléctrica el/los cable(s) de la fuente de alimentación CA tipo brick.

Advertência! Remova os cabos CA de alimentação brick da rede elétrica ao mover a unidade.

Avvertenza! Scollegare il cavo dell'alimentatore quando si sposta l'unità.



Warning! Only use attachments and accessories specified and/or sold by the manufacturer.

Avertissement! Utilisez seulement les attaches et accessoires spécifiés et/ou vendus par le fabricant.

Warnung! Verwenden Sie nur Zusatzgeräte und Zubehör angegeben und / oder verkauft wurde durch den Hersteller.

¡Advertencia! Utilice solamente los accesorios y conexiones especificados y/o vendidos por el fabricante.

Aviso! Utilize apenas equipamentos/acessórios especificados e/ou vendidos pelo fabricante.

Avviso! Utilizzare soltanto i collegamenti e gli accessori specificati e/o venduti dal produttore.

Warranty and Liability Information

Limited Warranty on Hardware

AJA Video Systems, Inc. (AJA Video) warrants that the hardware product, not including software components, will be free from defects in materials and workmanship for a period of five years from the date of purchase. AJA Video provides a separate software warranty as part of the license agreement applicable to software components.

If the Customer brings a valid claim under this limited warranty for a hardware product (hereafter, a "product") during the applicable warranty period, AJA Video will, at its sole option and as the Customer's sole remedy for breach of the above warranty, provide one of the following remedies:

Repair or facilitate the repair the product within a reasonable period of time, free of charge for parts and labor.

Replace the product with a direct replacement or with a product that performs substantially the same function as the original product.

Issue a refund of the original purchase price less depreciation to be determined based on the age of the product at the time remedy is sought under this limited warranty.

To obtain service under this warranty, the Customer must notify AJA Video of the defect before expiration of the warranty period and make suitable arrangements for the performance of service by contacting AJA Video support through the channels set forth on the support contacts web page at <https://www.aja.com/support>.

Except as stated, the Customer shall bear all shipping, packing, insurance and other costs, excluding parts and labor, to effectuate repair. Customer shall pack and ship the defective product to a service center designated by AJA Video, with shipping charges prepaid. AJA Video shall pay to return the product to Customer, but only if to a location within the country in which the AJA Video service center is located. SOME JURISDICTIONS DO NOT ALLOW THE EXCLUSION OF IMPLIED WARRANTIES OR LIMITATIONS ON APPLICABLE STATUTORY RIGHTS OF A CONSUMER, SO SOME OR ALL OF THE TERMS OF THIS PARAGRAPH MAY NOT APPLY TO YOU.

Limitation of Liability

Under no circumstances shall AJA video BE LIABLE IN ANY WAY FOR ANY LOST, CORRUPTED OR DESTROYED DATA, FOOTAGE OR WORK, OR FOR ANY OTHER INDIRECT, SPECIAL, INCIDENTAL OR CONSEQUENTIAL DAMAGES OR LOST PROFITS, OR FOR ANY THIRD PARTY CLAIM, IN CONNECTION WITH THE PRODUCT, WHETHER RESULTING FROM DEFECTS IN THE PRODUCT, SOFTWARE OR HARDWARE FAILURE, OR ANY OTHER CAUSE WHATSOEVER, EVEN IF AJA VIDEO HAS BEEN ADVISED OF THE POSSIBILITY OF SUCH DAMAGES. AJA VIDEO'S LIABILITY IN CONNECTION WITH THE PRODUCT SHALL UNDER NO CIRCUMSTANCES EXCEED THE PURCHASE PRICE PAID FOR THE PRODUCT. The foregoing limitations apply even if any remedy set forth in this LIMITED WARRANTY fails of its essential purpose. SOME JURISDICTIONS DO NOT ALLOW THE LIMITATION OF LIABILITY FOR PERSONAL INJURY, OR OF INCIDENTAL OR CONSEQUENTIAL DAMAGES, SO SOME OR ALL OF THE TERMS OF THIS PARAGRAPH MAY NOT APPLY TO YOU.

Governing Law and Language; Your Rights.

This limited warranty is the only warranty provided by AJA Video on the hardware product. It supersedes all prior or contemporaneous understandings regarding such subject matter. No amendment to or modification of this warranty will be binding unless in writing and signed by AJA Video. The laws of the State of California, USA will govern this warranty and any dispute arising from it. Any translation of this Agreement is intended for convenience and to meet local requirements and in the event of a dispute between the English and any non-English versions, the English version of this warranty will govern. This limited warranty gives you specific legal rights and you may have other rights that vary from jurisdiction to jurisdiction, some of which are noted above.

Index

Symbols

- 3G-AMA I/O Connections 5
- 3G-AMA Simplified Block Diagram 5

A

- AJA Support 2
- Audio-1 Tab Screen 15
- Audio-2 Tab Screen 16

B

- Breakout Cable Pinouts 7

D

- Default Operational Settings 8
- DIP Switches 6
- DIP Switch Settings 8
- Documentation
 - Downloading 11
 - Mini-Converter 10

I

- Info Tab Screen 18
- Installation 6

M

- Mini-Config
 - Installation on Mac 12
 - Installation on PC 11
 - Operation 14
 - Screen Description 14
 - Startup on Mac 13
 - Startup on PC 13
- Mini-Config Screen
 - Info Tab Screen 18
 - Update Tab Screen 17
- Mini-Converter Documentation 10

O

- Overview 4

S

- Saving Setups 13

U

- Update Tab Screen 17

X

- XLR DB25 Breakout Cable 7